

# An Experimental and Numerical Study on Thermal Performance of a Regenerator System with Ceramic Honeycomb

**Dong Soon Noh**

*Department of Energy Efficiency Research, Korea Institute of Energy Research*

**Sung Kook Hong, Hong Sun Ryou\*†**

*Department of Mechanical Engineering, Chung-Ang University*

**Seong Hyuk Lee**

*Research Institute of Production Engineering, Chung-Ang University*

The aim of this paper is to perform the experiment and the numerical simulation for investigating the heat transfer in a regenerator system with ceramic honeycomb and to suggest a useful correlation for optimization of the regenerator system. For achieving this, the effects of some parameters were investigated, e. g., switching time, cell size and length of honeycomb on the mean temperature efficiency. The measured temperatures by R-type thermocouples were compared with the predictions by means of the commercial package, STAR-CD. A useful correlation for thermal efficiency was newly proposed as a function of the normalized switching time, defined in terms of switching time, cell size and length of honeycomb. The results showed that the thermal efficiency is above 90% and the normalized heat exchange rate is higher than 80% when the normalized switching time is less than 1000.

**Key Words :** Regenerator, Honeycomb, Temperature Efficiency, Switching Time, Design Technology

## Nomenclature

$A_{cell}$  : Cross-sectional area of cell, of honeycomb  
 $L_r$  : Honeycomb length  
 $n_{cell}$  : The number of cell per unit area.  
 $Q_{cell}$  : Volume flow rate of exhausted gas per unit cell  
 $Q_t$  : Total volume rate of exhausted gas  
 $q^*$  : Normalized heat exchange rate  
 $T$  : Temperature  
 $T_{eff}$  : The mean temperature efficiency  
 $t_{pass}$  : Flow passage time  
 $t^*$  : Normalized switching time

$t_f$  : Switching time  
 $\eta$  : Efficiency

## Subscripts

in : Inlet region  
 out : Outlet region  
 h : Heating process  
 c : Regenerating process

## 1. Introduction

Generally, a regenerative combustion system has been widely used to save energy in the industries because its thermal efficiency is generally high from a viewpoint of using the waste heat. Up to now, a number of researchers have continuously studied how to use the waste heat much more efficiently. Willmot (1993), Akter and Hossain (1997) and Kluka and Wilson (1998) have extensively investigated the heat transfer in the regenerating process and provided some of analytic solu-

† First Author

\* Corresponding Author.

E-mail : cfdmec@cau.ac.kr

TEL : +82-2-820-5280 ; FAX : +82-2-814-9476

Department of Mechanical Engineering, Chung-Ang University, 221, Heuksuk-dong, Dongjak-ku, Seoul 156-756, Korea. (Manuscript Received June 5, 2000; Revised December 5, 2000)

tions for heat transfer. In addition, Monte (1999) has suggested an analytical solution of counter-current regenerator problem when its cyclic state is established for steady flows. Saastamoinen (1999) also presented analytical solutions for gas and solid temperature in terms of time and space in cross-flow regenerators. Suzukawa *et al.* (1999) performed the experiment for the regenerative combustion system and showed the saving effect of the fuel theoretically and numerically in the case that highly pre-heated air was used for combustion. In addition, Muralikrishna (1999) has proposed the analytical solutions with and without including conductive terms. The above researches can help us in understanding characteristics for the regenerator system. Nevertheless, it is very difficult to obtain a useful technology for optimal design of regenerator, which is capable of being used in the industry effectively. Therefore, more practical and extensive studies should be performed in order to give better understandings of heat transfer characteristics and to provide useful information for an optimal design of the regenerator system.

As a matter of fact, it is indispensable to understand the heat transfer characteristics of the regenerator, typically using a porous medium such as honeycomb or spheres, in order to optimize the regenerator system. In this article, experimental and numerical studies were carried out mainly for the regenerator with ceramic honeycomb known as an orthotropic porous medium. A schematic diagram for the regenerator considered in this article is shown in Fig. 1. There are

two processes, i. e., a “heating process” and a “regenerating process” for a typical regenerator system. In the heating process, the hot gas exhausted from the burner enters into honeycomb and passes through it. The heat of exhausted hot gas is accumulated in honeycomb and consequently the temperature of honeycomb increases gradually as time goes on. At a specified time, so called switching time, the flowing direction is instantaneously changed as seen in Fig. 1 in an opposite direction by the switching valve and the air with ambient temperature from blower begins to enter into honeycomb. This process occurring after the switching time is called a “regenerating process”, in which heated honeycomb is cooled because of heat transfer between the heated honeycomb and cold air from blower. During this process, the heated air from honeycomb enters into the burner and is used for combustion by mixing with the fuel. The highly preheated air from the regenerator not only reduces the fuel consumption considerably, but also highly enhances the temperature in the furnace. These processes are repetitive and periodic and controlled by the switching valve.

The main aim of the experiment is to examine the heat transfer in a regenerator system with ceramic honeycomb and to propose a useful correlation for optimization of the system. For achieving this goal, it was investigated how the thermal efficiency and the rate of heat exchange are affected by various parameters, e. g., the switching time, cell size and length of honeycomb. The switching time is defined as one at which the flow directions of gas and air change reversibly, which is an important factor because the rate of heat exchange in the heating process is highly affected.

Up to now, most of researchers have taken the treatment based on Darcy's flow for porous media such as honeycomb and packed beds (Kaviany, 1995). This is not only because it is very difficult to realize the full geometry of porous media but also because, even if it is possible, there occurs the complexity due to turbulent flows. In addition, there may be uncertainty about the permeability of porous media and the heat transfer coefficient

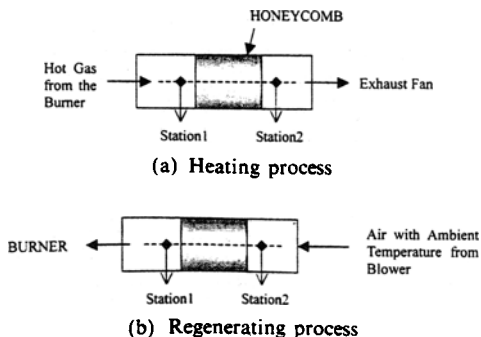

Fig. 1 Schematic diagram for heating and regenerating processes

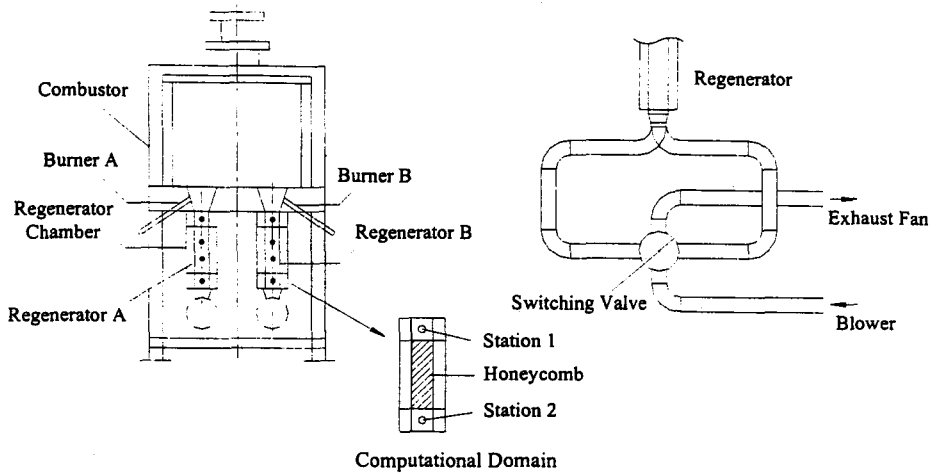

Fig. 2 Schematic diagram of experimental apparatus

for the conjugate heat transfer. Recently, the outstanding development of computer has resulted in the fact that the full simulation for porous media flows may be possible without certain treatments as referred above. As an additional task of this work, the numerical simulation for predictions of heat transfer characteristics in a regenerator system was performed in order to show that the full simulation is possible. It turns out that the numerical simulation reduces the number of experimental cases and saves costs. It is also capable of giving a theoretical background for the experimental results and a basic concept for experiment. In this study, numerical simulations were performed by STAR-CD, widely known as a commercial code. The predicted temperatures were compared with experimental data.

## 2. Experimental Apparatus

Figure 2 shows the schematic diagram of the experimental apparatus for the regenerative combustion system with ceramic honeycomb. The system mainly consists of two regenerator chambers including identical ceramic honeycomb, connected to each burner, a switching valve and a combustor. Actually, the switching valve controls two processes, i. e., the heating process and the regenerating process as referred previously by means of operating the burners A and B in turn. In the heating process, the direction of flow is

from the burner A to burner B and honeycomb in the regenerator B is heated by hot gas from the burner A. Contrary to this, after switching time, the regenerating process is commenced and the direction of flow is changed in an opposite direction by switching valve shown in Fig. 2. In the regenerating process, the honeycomb in the regenerator B is cooled by entering the cold air from the blower. The preheated air by honeycomb in the preceding process enters into the burner B and then the honeycomb in regenerator A is heated by the hot gas from burner B. A series of processes are controlled by the switching valve and the burner successively.

We performed the experimental work for several ceramic honeycombs made out of cordierite of 50% and mullite of 50%. The diameter of honeycomb was 70 mm and four different types of honeycomb, i. e., 100 mm  $\times$  100 cell, 100 mm  $\times$  300 cell, 200 mm  $\times$  100 cell and 200 mm  $\times$  300 cell, were taken for examining the effects of length and cell size of honeycomb on heat transfer. In addition, the switching times of 10, 20, 30, 40, 60, and 90 seconds were taken for investigating the influence of the switching time on heat transfer in the regenerator system. A ceramic insulator was used for each regenerator in order to minimize the heat loss. At inlet of regenerator, the temperature of exhausted hot gas from the burner was maintained about 1000 °C by adjusting the flow rates of air and fuel. In this case, the air/fuel ratio

and the combustion capacity were 1.3 and about 26 kW, respectively. In the present experiment, Chungnam town gas was used as a fuel (88% methane and 10% butane). As shown in Fig. 2, the temperature measurements were carried out by R-type thermocouples with a diameter of 0.5 mm at the inlet and outlet of the cylindrical honeycomb regenerator, not inside the cell. The measurement location was on the axis, e. g. at the center of the cross section as seen in Fig. 1. The data signals during the switching time were obtained by collecting five data of temperature per second using A/D converter (DT Vee). The translation program was used to store the temperature data and to calculate the mean temperature efficiency in heating and regenerating processes.

### 3. Numerical Study

As shown in Fig. 3, the calculation domain was taken by selecting a regenerator because of its periodic feature. The numerical simulation was performed using grids of 29000, produced by means of the commercial package of ICEM-CFD (ICEM-CFD Manual, 1998) and STAR-CD (STAR-CD Manual, 1998), widely used in real industry fields. In order to reduce the computational cost and storage, we adopted one fourth of honeycomb as seen in Fig. 3. The continuity, momentum and energy equations were solved by finite volume method in a three-dimensional manner. To simulate unsteady flows, PISO algorithm was used and the standard  $k-\epsilon$  model was adopted for the turbulent flow. The conjugate heat transfer between ceramic honeycomb and gas was considered and the conditions of inlet and outlet regions as listed in Table 1 were taken from experimental data. At an initial stage of calculation, the inlet and outlet conditions were applied to sides A and B, respectively. At the specified switching time, the inlet region instantaneously became the outlet region after the switching time, and the outlet region was replaced with the inlet region where the inlet conditions listed in Table 1 are applied to side B. During the total time of calculation, this process is repeated in turn. In the present calculation, it was assumed that the hot

**Table 1** The inlet conditions for each process in the numerical calculation

	Heating Process	Regenerating Process
Velocity	5.630 m/s	1.732 m/s
Temperature	1000 °C	20 °C
Density	0.277 kg/m <sup>3</sup>	1.205 kg/m <sup>3</sup>
Turbulent kinetic energy	0.0792 m <sup>2</sup> /s <sup>2</sup>	0.00749 m <sup>2</sup> /s <sup>2</sup>
Dissipation rate	0.2865 m <sup>2</sup> /s <sup>3</sup>	0.00833 m <sup>2</sup> /s <sup>3</sup>

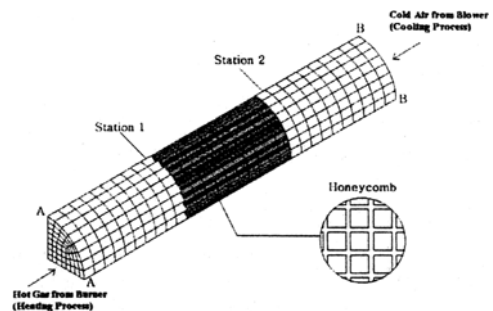

**Fig. 3** Computational domain for numerical calculation

gas exhausted from each burner could be regarded as the hot air whose properties were determined from the database included in STAR-CD. The properties of ceramic honeycomb such as thermal conductivity and specific heat capacity were determined from the curve-fitted relationships based on the experimental data.

## 4. Results and Discussion

### 4.1 Comparison of experimental data with predictions

Figure 4 represents the measured data and the predicted temperature at stations 1 and 2 for 1<sup>st</sup> period in the case of the switching time of 30 sec. This figure also shows the effects of length of honeycomb on the temperature for 100 cell. Initially during 30 sec, it is seen that the temperature of both regions of inlet and outlet is increasing gradually as time goes on. After the switching time, at which the flow directions are changed, the decreasing trend of temperature can be observed because the heat transfer occurs between entering

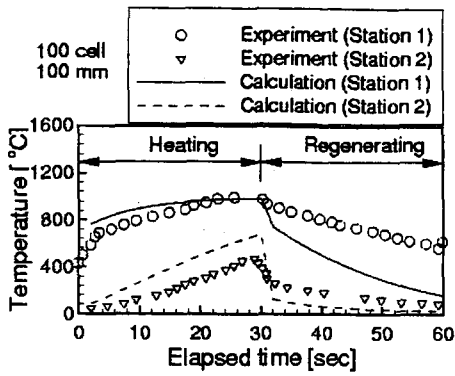

(a) 100 cell & 100 mm

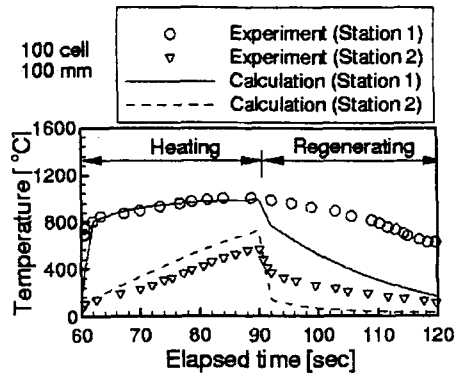

(a) 100 cell & 100 mm

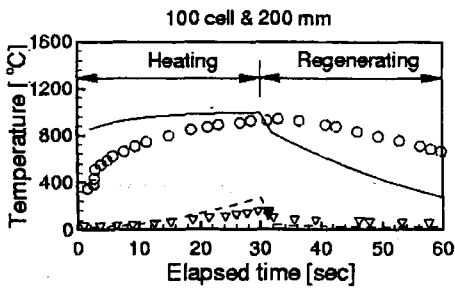

(b) 100 cell & 200 mm

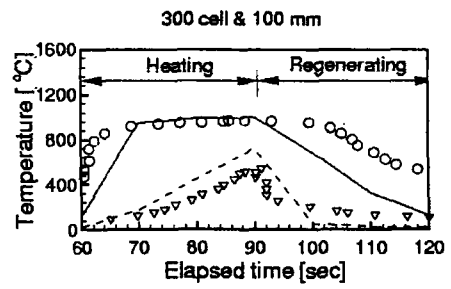

(b) 300 cell & 100 mm

Fig. 4 Effects of gas temperature on honeycomb lengths of 100 mm and 200 mm for 1st period

Fig. 5 Effects of gas temperature on honeycomb cell numbers of 100 and 300 for 2nd period

air from the blower and the heated honeycomb in the heating process. The difference of temperature between two stations means the heat exchange between exhausted hot gas and honeycomb by the conjugate heat transfer. It is seen that the increased difference of temperature between two stations can be observed as the length of honeycomb increases. This is because of the increased surface area for heat transfer. Figure 5 shows the effect of the cell size of honeycomb on heat transfer in the system. As referred previously, the similar trend of temperature can be observed. Although the gas temperature slightly decreases as the cell size decreases, the variation of cell size hardly affects the heat transfer. This shows that the length of honeycomb is the more important factor than the cell size.

In the heating process, it is seen that the maximum temperature at stations 1 and 2 are close to experimental data. From Fig. 4, it can be predicted effectively that the gas temperature at outlet (station 2) decreases as the honeycomb

length increases. However, considerable differences between the prediction and the measured data occurred at initial stage of elapsed time in this process. This problem may be because the STAR-CD is not capable of predicting the initial loss of heat near the burner occurring at an initial stage of elapsed time in real situation. The initial loss occurs between the initially cooled insulator and the exhausted hot gas near an initial stage of elapsed time, indicating that a certain time is required in order that the insulator works effectively. It is indispensable to apply the adiabatic condition to the wall because there is no relevant information about the initial loss of heat. This problem results in overestimation of gas temperature near initial stage of elapsed time.

In the regenerating process, the results show effectively that the gas temperature at station 2 rapidly decreases as the length of honeycomb increases. A qualitative trend of predictions is similar to that of experimental data. However, the slight underestimation of temperature can be

found at station 2, while the numerical simulation fails to predict the gas temperature at station 1 effectively in the regenerating process. Possible explanation about this may be that the STAR-CD cannot describe the flow disturbances due to sudden changes of boundary conditions. In real situation, when the switching valve is working on, there may be strong interactions between the preceding flow and the reversed flow. Unfortunately, it is hard to mimic this phenomenon in the present simulation using STAR-CD because of elliptic characteristics of governing equations.

As referred previously, the full simulation for porous media flows have been limited because of its complexity. Our concern is mainly focused on the prediction of qualitative trend, rather than on the accuracy of predictions. In addition, the main aim of the present numerical simulation is in showing that the full simulation for the regenerator system with honeycomb may be possible with the commercial code, STAR-CD. Hence, it turns out that more elaborated treatment in STAR-CD should be studied in order to effectively resolve several problems, appearing in the present predictions. Nevertheless, it is thought that the STAR-CD is usable in performing the full simulation for porous media flows as the regenerator system dealt with in the present study. By and large, the present predictions are acceptable for prediction of overall trend, compared to experimental one although there are some discrepancies in both heating and regenerating processes.

#### 4.2 Suggesting of a new correlation for optimal design of the system

In the present study, an experimental correlation on heat transfer was proposed on the basis of experimental data. These relationships may be useful for optimal design for the regenerative combustion system used in real industries. Let us define thermal efficiencies for each process to analyze the performance of regenerator as follows.

Heating Process

$$\eta_h = \frac{(T_{h,in} - T_{h,out})}{(T_{h,in} - T_{c,in})} \quad (1)$$

Regenerating Process

$$\eta_c = \frac{(T_{c,out} - T_{c,in})}{(T_{h,in} - T_{c,in})} \quad (2)$$

where  $T_{h,in}$  represents the averaged temperature of gas at inlet region during the heating process. The defined efficiencies can be obtained by averaging the temperature data, measured at inlet and outlet regions. Using Eqs. (1) and (2), we can finally define the mean temperature efficiency as follows.

$$T_{eff} = (\eta_h + \eta_c) / 2 \quad (3)$$

Recuperator/regenerator is generally used for heating up air or gas. The purpose of the study is to optimize the regenerator for high temperature combustion air. That is why the mean temperature efficiency is considered in the present study. The allowable maximum amount of heat regeneration is obviously influenced by the heating process. Hence, the regenerator efficiency was defined

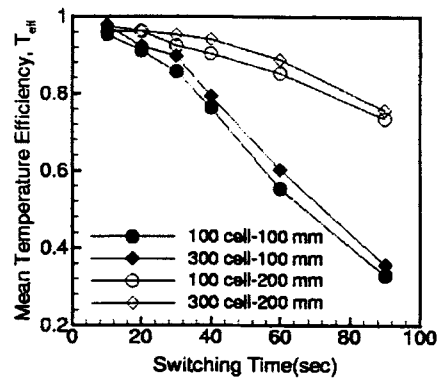

(a) Mean temperature efficiency

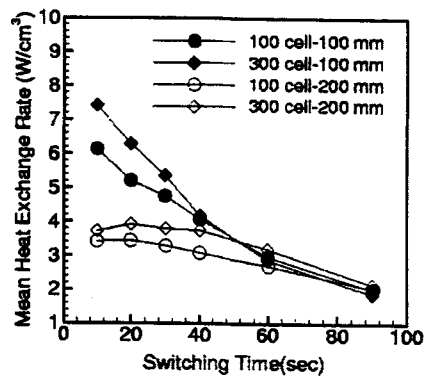

(b) Mean heat exchange rate

Fig. 6 The mean temperature efficiency and heat exchange rate for switching time

as the averaged value for two processes.

Figure 6(a) shows the influence of the switching time, length and cell of honeycomb on the mean temperature efficiency. The length of honeycomb strongly influences the mean temperature efficiency as the switching time increases, while the minor effect of cell size can be observed for given values of switching time and length of honeycomb. In addition, mean temperature efficiency decreases as the switching time increases for given cell size and length of honeycomb because of the restricted heat capacity of honeycomb, suggesting that the use of excessive switching time may decrease efficiency.

Mean heat exchange rate is associated with the heat accumulation or regeneration during the switching time and its amount during the switching time can be determined from heat differences between the inlet and outlet regions. Typically, the heat can be calculated from temperature, density and heat capacity, which are averaged during the switching time, for various test conditions such as air/fuel ratio and flow rate of fuel. From Fig. 6(b), the mean heat exchange rate decreases rapidly as the switching time increases for length of 100mm. All cases show a similar trend after 60 sec, indicating that there exists an optimal switching time, independent of cell size or length of honeycomb.

However, it may be difficult from Fig. 6 to represent the coherent behavior for heat transfer effectively because the mean temperature efficiency and the rate of heat exchange for each case are affected by various parameters. Hence, some normalized parameters are offered in order to understand the heat transfer characteristics more effectively. This approach may be helpful for optimal design of the regenerative combustion system used in real industry. First, a flow passage time  $t_{pass}$ , representing the time during which exhausted gas passes through the honeycomb per unit cell, is defined as follows.

$$t_{pass} = \frac{L_r A_{cell}}{Q_{cell}} \quad (4)$$

The volume flow rate of exhausted hot gas per unit cell  $Q_{cell}$  can be expressed by a total volume

rate of exhausted gas  $Q_t$  the cross-sectional area of regenerator,  $D_r^2$ , and the number of cell per unit area  $n_{cell}$ . Therefore, the above equation can be rewritten as

$$t_{pass} = \frac{L_r A_{cell} D_r^2 n_{cell}}{Q_t} \quad (5)$$

Finally, a normalized switching time  $t^*$  is defined as the ratio of the switching time  $t_f$  to a flow passage time in Eq. (5).

$$t^* = \frac{t_f}{t_{pass}} = \frac{t_f Q_t}{L_r A_{cell} D_r^2 n_{cell}} \quad (6)$$

where the physical meaning of dimensionless time,  $t^*$ , is the passage number of exhausted gas whose volume rate passes through one cell of honeycomb during the switching time. This parameter representing the number of series may be defined on the basis of assumption that the heat is constantly stored in honeycomb for each passage of gas through honeycomb. In addition, a normalized heat exchange rate can be calculated as follows.

$$q^* = \frac{\text{mean heat exchange}}{\text{heat input}} \quad (7)$$

This relationship represents the amount of heat exchange for given capacity of the burner and the heat input can be obtained by using the averaged values for temperature, density and heat capacity measured at inlet location during the switching time.

Figure 7(a) represents the mean temperature efficiency for normalized switching time. It is seen from Figs. 7(a) and (b) that the coherent and consistent trend can be observed for efficiency and heat exchange rate, independent of cell sizes and lengths of honeycomb. For all cases, the normalized heat exchange rate decreases as  $t^*$  increases with the consistent trend, similar to that seen in Fig. 7(a). From these results, two relationships for the mean temperature efficiency  $T_{eff}$  and the normalized heat exchange rate  $q^*$  can be found as follows.

$$T_{eff} = 1.02 - 9.325 \times 10^{-5} t^* - 1.043 \times 10^{-8} t^{*2} \quad 200 < t^* < 5200 \quad (8)$$

$$q^* = 1.074 - 3.098 \times 10^{-4} t^* + 2.541 \times 10^{-8} t^{*2} \quad 200 < t^* < 5200 \quad (9)$$

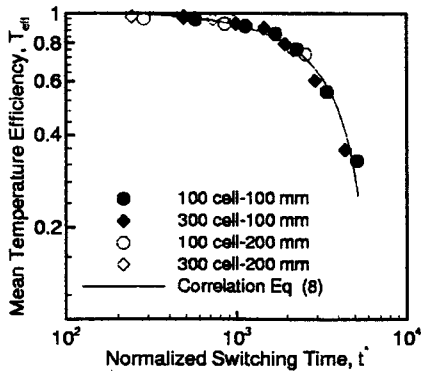

(a) Mean temperature efficiency

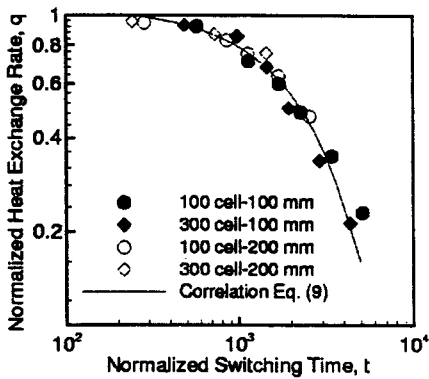

(b) Mean heat exchange rate

**Fig. 7** The mean temperature efficiency and normalized heat exchange rate for the normalized switching time,  $t^*$

The above quadratic relationships were expressed using log-scales because the range of normalized switching time is relatively larger than that of temperature efficiency or heat exchange rate as seen in Fig. 7. Meanwhile, it is seen in these figures that when  $t^*$  is less than 1000, the mean temperature efficiency is higher than 90% and the normalized heat exchange rate is higher than 80%. Therefore, it can be suggested that the recommended value of  $t^*$  be about 1000 as an upper limit for optimal design of the present system. Actually, the upper limit for the normalized switching time may be of an important meaning rather than the lower limit for optimization of the system, being used in the industry. However, it is thought that additional experimental results can help in determining the lower limit.

## 5. Conclusions

The experimental and numerical studies were performed on the regenerator system with honeycomb and the following conclusions could be drawn.

(1) The length of honeycomb and the switching time are major factors affecting the mean temperature efficiency, relative to the cell size of honeycomb. As the length of honeycomb increases, the rate of heat transfer from the hot gas to the honeycomb increases and therefore the temperature of gas passed through honeycomb decreases. This is because of increase of surface area for heat transfer.

(2) Two useful relationships for heat transfer were newly introduced by using several dimensionless parameters. One of which is for the mean temperature efficiency and the other for the heat exchange rate. It could be suggested that the recommended value of normalized switching time be about 1000 as an upper limit for optimal design of the present system. On designing the regenerator with honeycomb, the present correlations may be useful for optimal design of regenerator system.

(3) A qualitative trend of predictions is similar to that of experimental data. However, there are some discrepancies between the predictions and the measured data. In particular, the numerical simulation fails to predict the gas temperature at station 1 effectively in the regenerating process. This may be because the STAR-CD cannot describe the flow disturbances due to the sudden change of flow directions. Hence, it turns out that more elaborated treatment in STAR-CD should be studied in order to effectively resolve the appearing problems in this paper. Nevertheless, it is thought that the STAR-CD is usable in performing the full simulation for the regenerator system.

## Acknowledgment

This material is based upon work supported by the GGRC (Greenhouse Gas Research Center).



## References

- Akter, S. and Hossain, I., 1997, "Waste Heat Utilization in a Ceramic Industry," *International Journal of Energy Research*, Vol. 21, pp. 1215 ~1221.
- ICEM-CFD Manual. 1998.
- Kaviani, M., 1995. "Principles of Heat Transfer in Porous Media," Second Edition, Springer-Verlag NY.
- Kluka, J. A. and Wilson, D. G., 1998, "Low-Leakage Modular Regenerators for Gas-Turbine Engines," *Journal of Engineering for Gas Turbines and Power*, Vol. 120, pp. 358~362.
- Monte, F. de, 1999, "Cyclic Steady Thermal Response of Rapidly Switched Fixed-Bed Heat Regenerators in Counter-Flow," *International Journal of Heat and Mass Transfer*. Vol. 42, pp. 2591~2604.
- Muralikrishna, S., 1999, "Study of Heat Transfer Process in a Regenerator," *Trans IchemE*. 77 (part A), pp. 131~137.
- Saastamoinen, J. J., 1999, "Heat Transfer in Cross-Flow Regenerators," *International Journal of Heat and Mass Transfer*, Vol. 42, pp. 3205~3216.
- STAR-CD Manual. 1998
- Suzukawa, Y., Sugiyama, S., Hino, Y., Ishioka, M. and Mori, I., 1997, "Heat Transfer Improvement and NOx Reduction by Highly Preheated Air Combustion," *Energy Convers. Mgmt.* Vol. 38, pp. 1061~1071.
- Willmott, A. J., 1993. "The Development of Thermal Regenerator Theory from 1931 to the Present," *Journal of the Institute of Energy*, Vol. 66, pp. 54~70.